



Keep the address of the company.
Not suitable for children under 3 years!
Contains small parts!

How you can help the environment: Please return the parts to a certified provider at the end of their useful life!

Solar Racing Car

Wooden building kit with gearbox, runs on "solar fuel!"

MADE IN EUROPE



Item no.: 40306



ASSEMBLY INSTRUCTIONS

1 ASSEMBLY INSTRUCTIONS, parts:

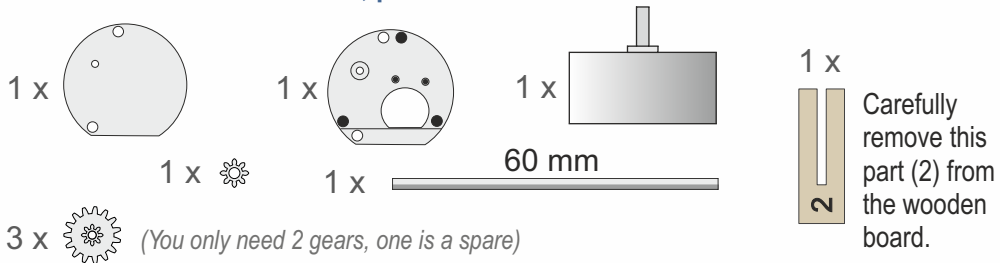

A Find the following parts and lay them out:

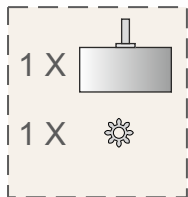

Place the small gear on the table and carefully slide the motor shaft into the small gear from above. The gear will be flush with the shaft.

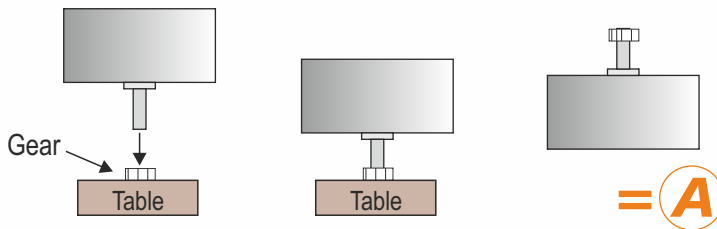

- B** Now slide the motor into the gearbox casing. Turn the motor so the cable comes out at the bottom.

Find the following parts and lay them out:

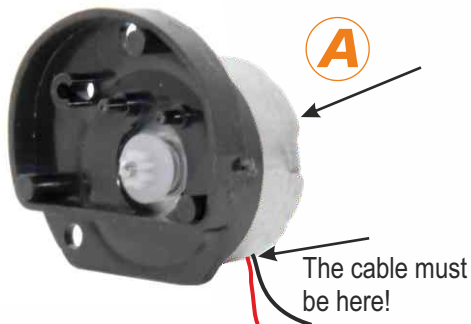
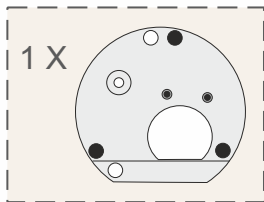

- C** Find the following parts and lay them out:

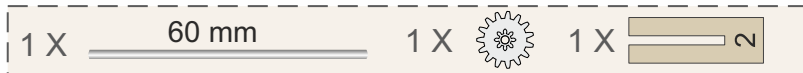

Take the 60 mm shaft (use the ruler at the right to measure if the length is correct) and carefully tap it into the double gear (the **smaller** of the double gears is at the bottom!). Then apply some pressure and slide the gear approx. 1 cm onto the shaft. Use the hammer to slowly tap the shaft all the way into the spacing template. The shaft will now still stick out 36 mm.

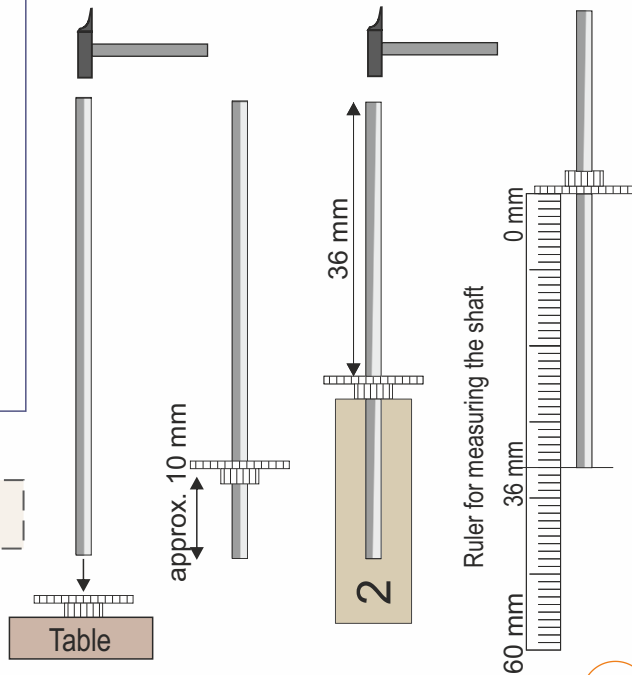

= **B**

D Now slide the second double gear, with the large gear in front, onto the bolt in the gearbox casing. Then assemble the gear/shaft assembly (B). Also slide this with the large gear in front into the hole for the shaft guide. If you now slightly turn the shaft, all gears must turn.

Find the following parts and lay them out:

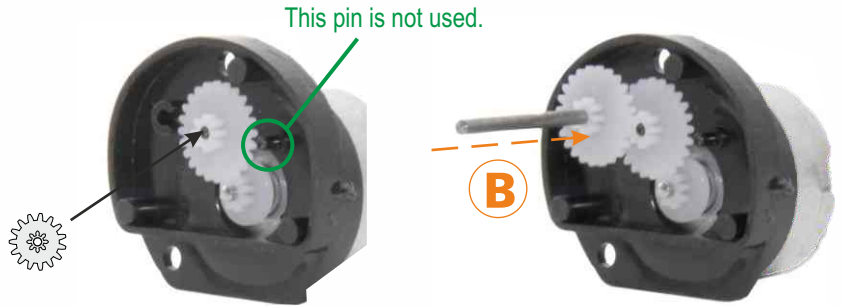
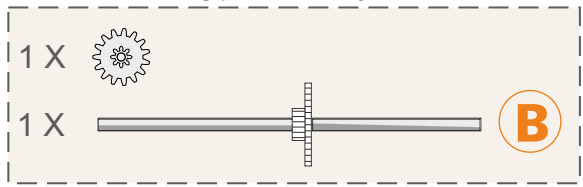

E Find the following part and lay it out:

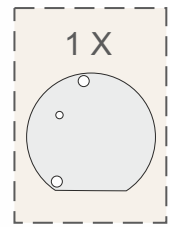

Fit the gearbox cover and slightly squeeze the gearbox casing in three areas with pliers. The casing will close.

If the shaft turns, you did it correctly! Great!

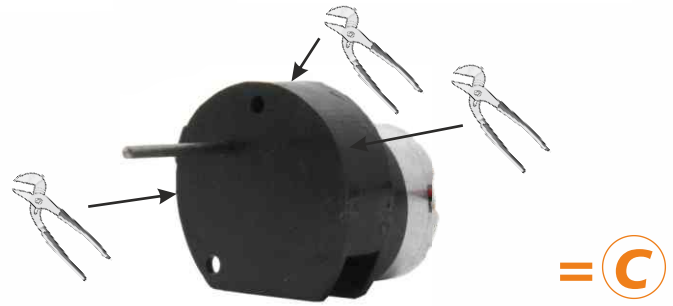

2

ASSEMBLING THE RACING CAR



Carefully read the information below before starting assembly:

Glue notice:

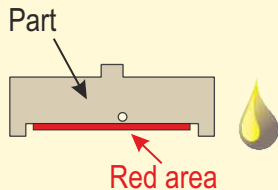

You will need to apply glue in the red areas just before assembly. Use glue sparingly. You can clean excess glue with a cloth. Close the glue after assembly. Perhaps you can use it for another project.

Assembly order : 2 (1.)

Every part has a separate red part number (in this case "2"). Behind it is a number in brackets (in this case "1") . The number in brackets (blue) indicates when the part will be used. Assembly is in sequence, always first the part marked (1), then (2), etc.

Important information:

Some parts have peculiarities which must be taken into account. This can be e.g. the orientation of the part or something different. These parts are marked with **Note**. Follow the information in the note.

PARTS:

Carefully remove the individual wooden parts from the wooden board:

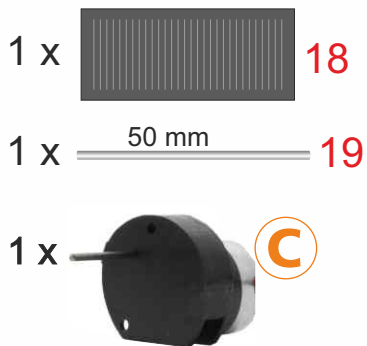
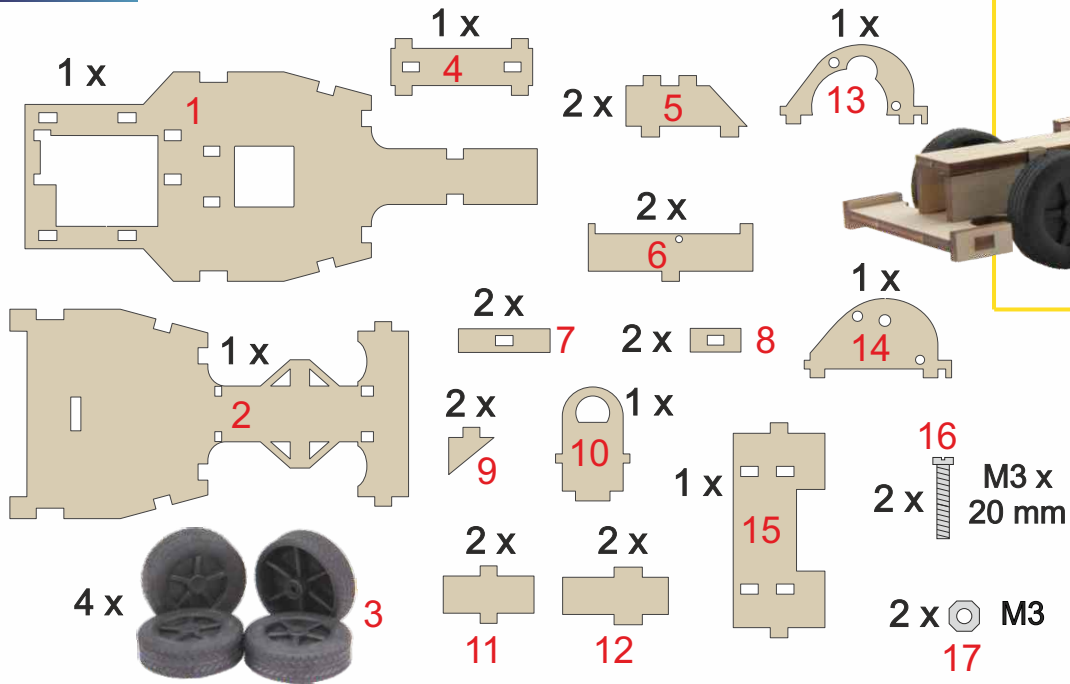

A

Find the following parts and lay them out:

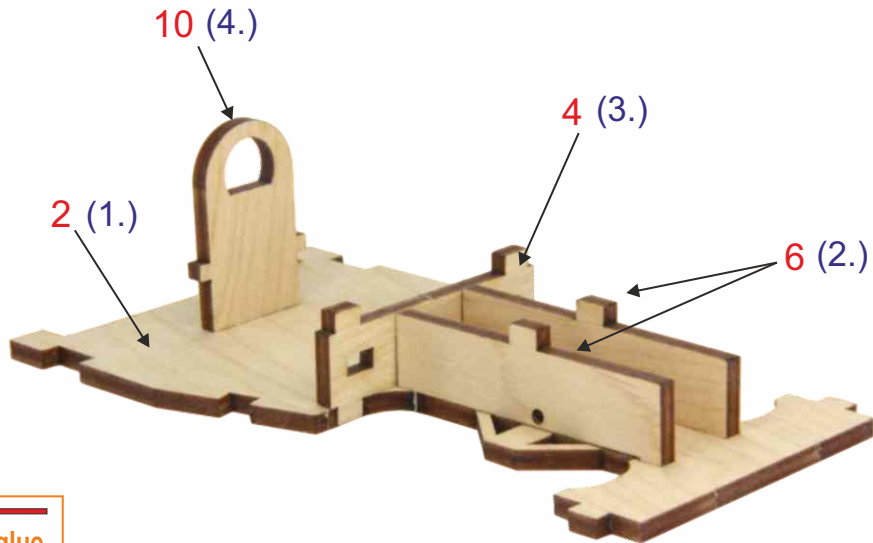
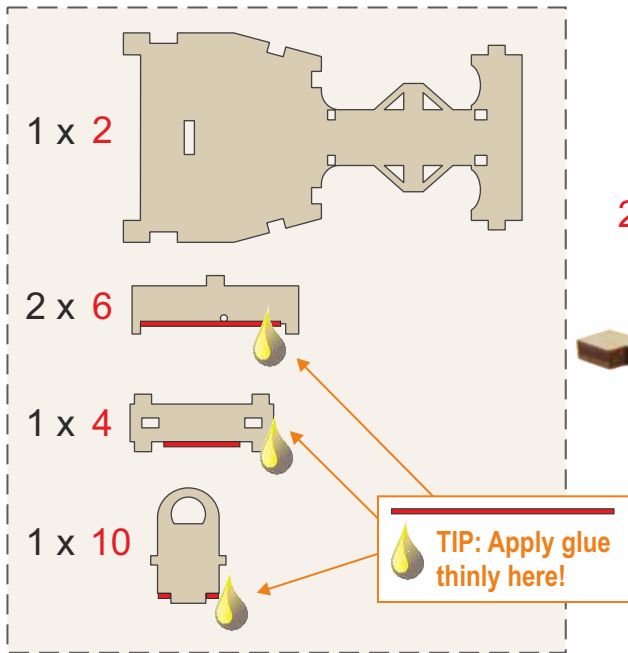

B Find the following parts and lay them out:

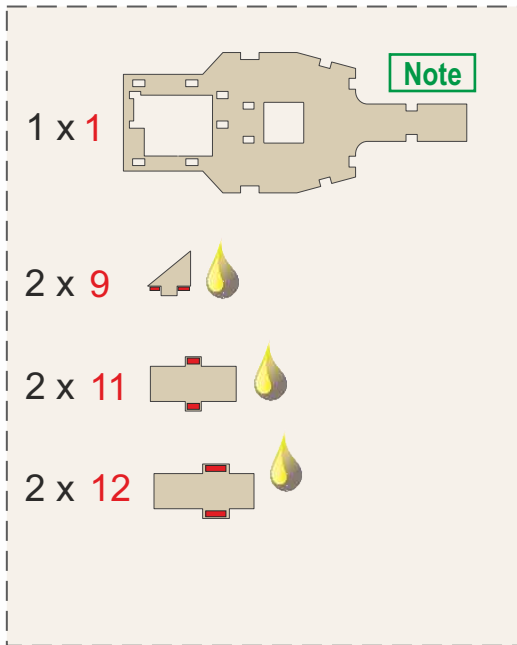

TIP:

Apply glue sparingly

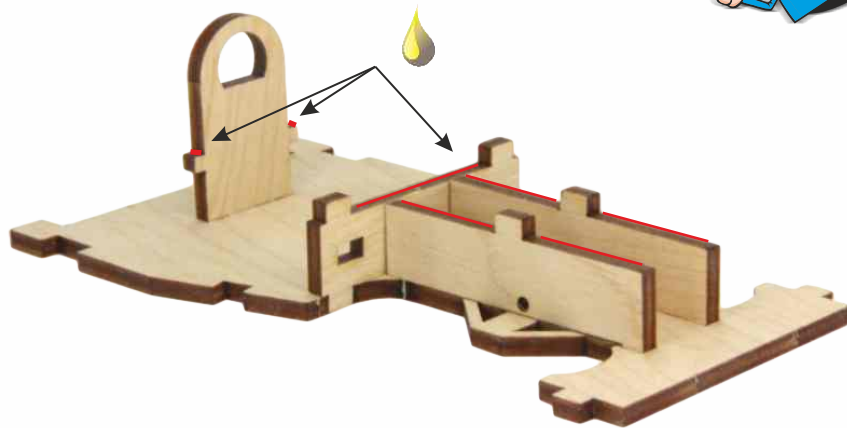

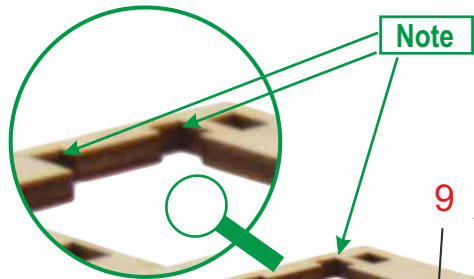

Important note:

You need to glue the correct side of part 1 onto the body: i.e. there are two notches at the back which must be in the correct location.

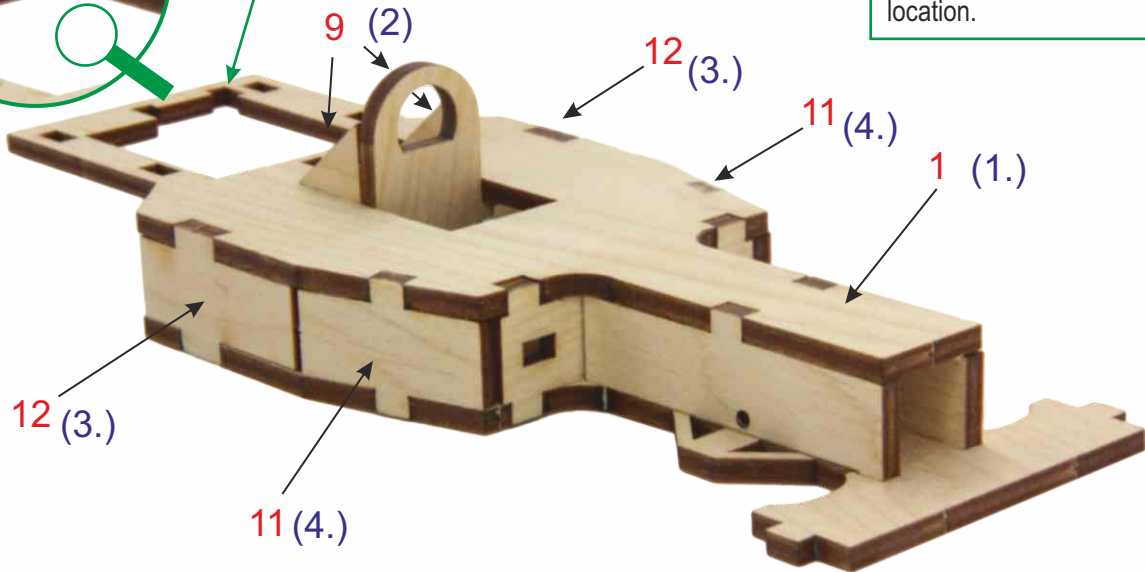

Allow glue to dry for 10 min.

C Find the following parts and lay them out:

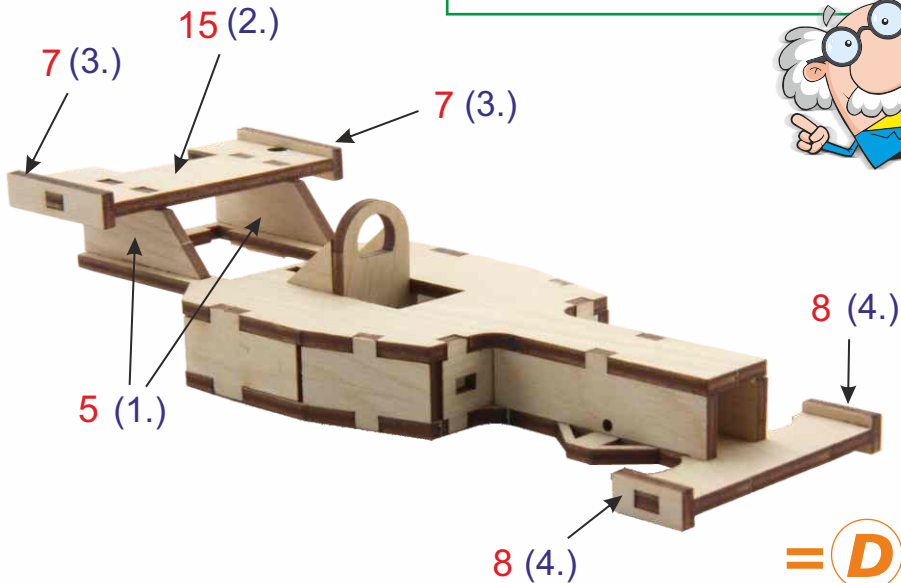
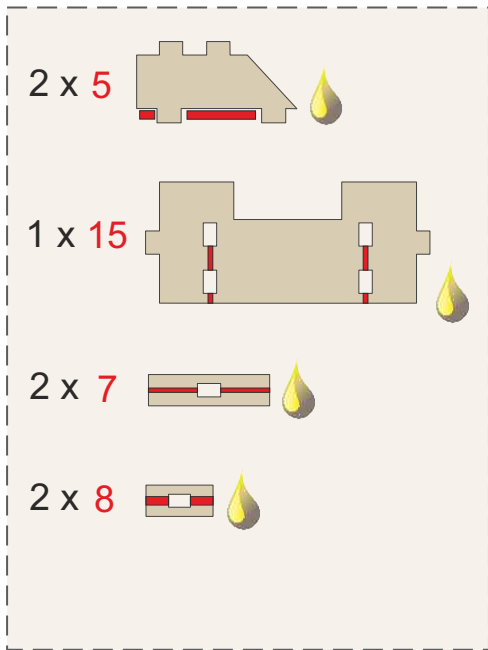

Important note:

Part 15: The notch in the spoiler faces the back of the racing car



D Find the following parts and lay them out:

1 x 14

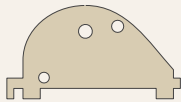

2 x 16



M3 x
20 mm

1 x 13



2 x 17



M3

Note

16 (2.)

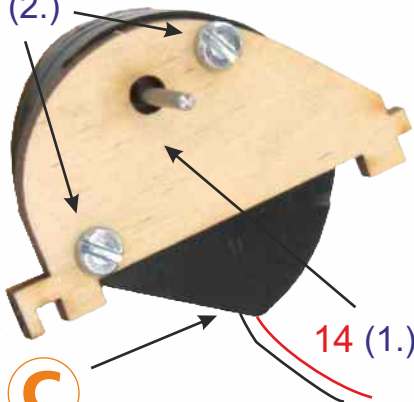

14 (1.)

C

17 (2.)

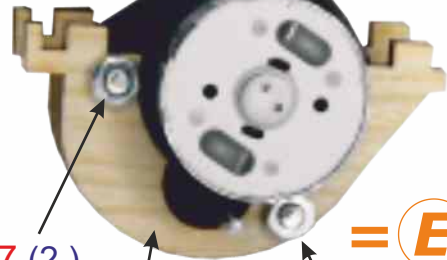

13 (1.)

17 (2.)

E

Important note:

Slightly tighten the nuts (2 x part 17) with your fingers. The axle must still turn easily by hand. If the nuts are too tight, the gearbox will lock. In this case, slightly loosen the nuts.



E Find the following parts and lay them out:

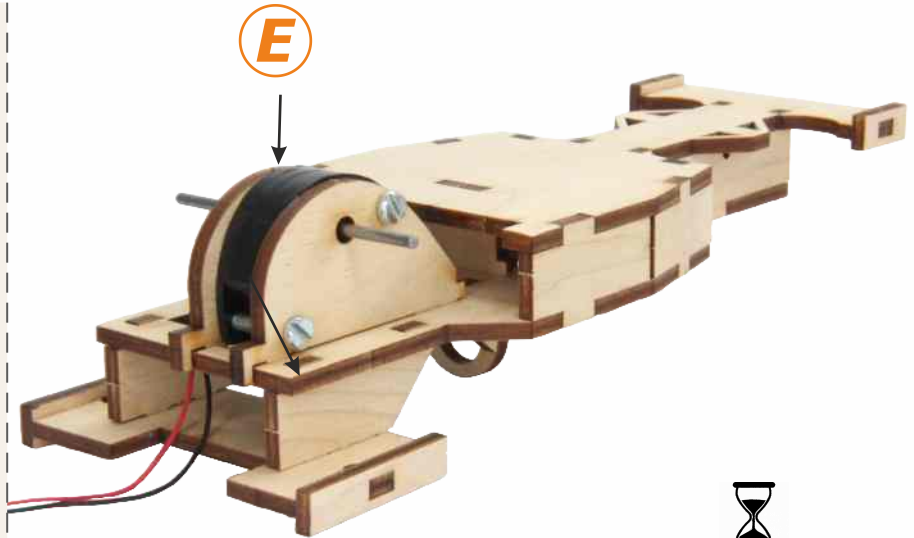
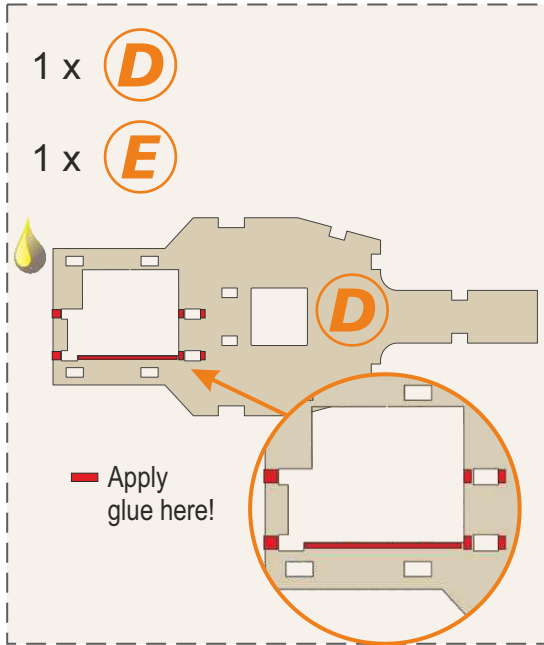

Allow glue to dry
for 10 min.

F Find the following parts and lay them out:

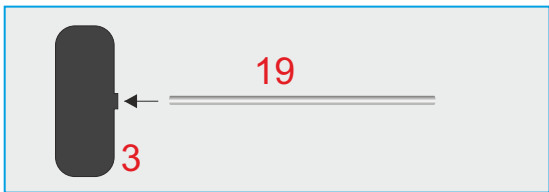
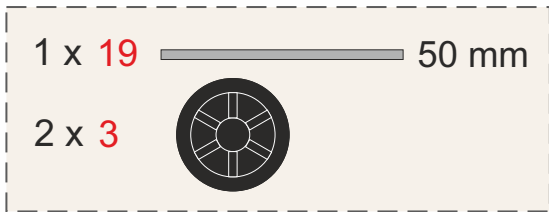

When the wheels are mounted to the axle, it must turn easily. If the axle is difficult to turn, simply pull the wheels slightly outward until the axle turns freely again.

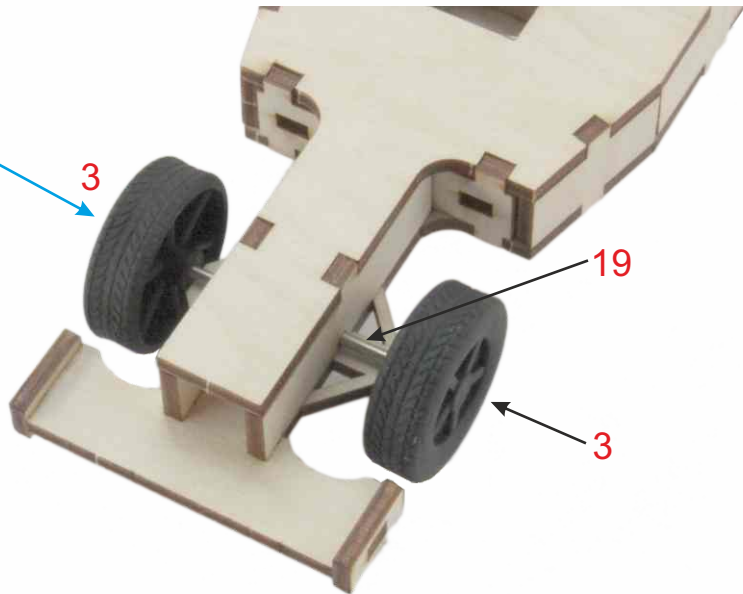

G Glue to solar cell onto the spoiler, connect the cable and attach the wheels.

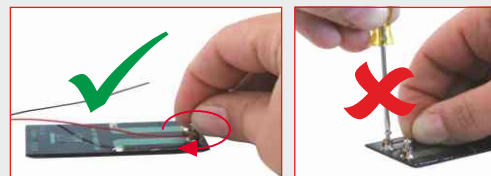
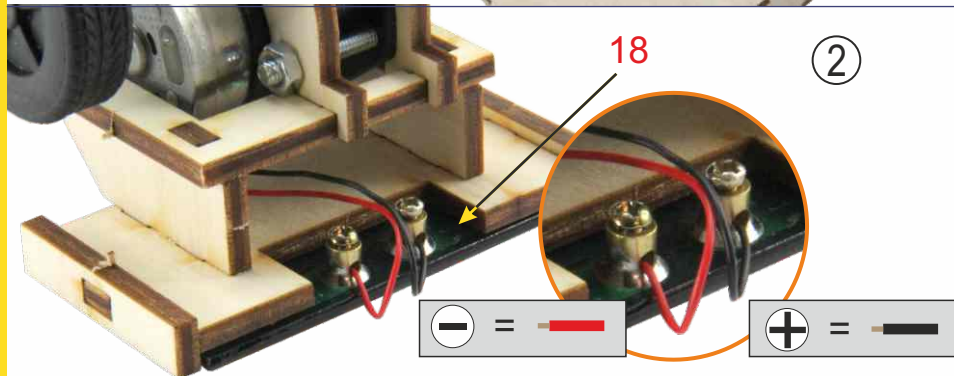
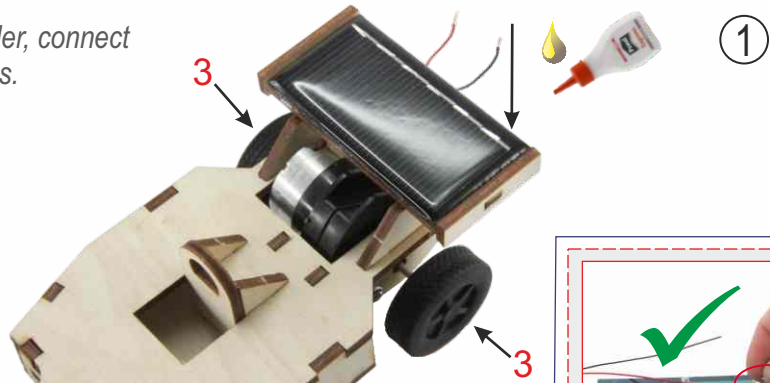
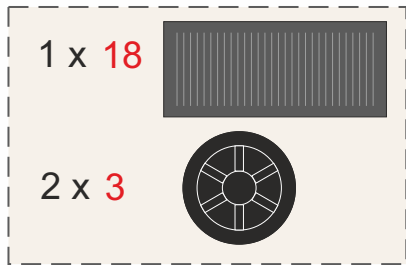

CAUTION: Information for connecting the cables to the solar cell: Slightly loosen the screws, insert the cables in the holes and tighten the screws with minimal force!

Do not tighten screws with a screwdriver to avoid shearing the cables!

H CONGRATULATIONS - Your racing car is finished and you are ready to race!



To ensure your solar racing car will be really fast, it will need pure "fuel" from direct sunlight!

The car will therefore run best outside. Or use a halogen lamp indoors to power the solar cell.



TIP: If the racing car runs backwards, switch the red and black cable.



Hier geht es zur Anleitung:



<https://www.sol-expert-group.de/Solar-Produkte/Modelle-aus-Holz/Solar-Holz-Steckbausätze/Solar-Rennauto::1113.html?language=de>

Click here for the instructions:



<https://www.sol-expert-group.de/Solar-products/Models-made-of-wood/Solar-wooden-building-kits/Solar-racing-car::1113.html?language=en>

Cliquez ici pour les instructions:



<https://www.sol-expert-group.de/Articles-solaires/Modeles-reduits-en-bois/Kits-dassemblage-solaires-en-bois/Voiture-de-course-solaire::1113.html?language=fr>

Klik hier voor de instructies:



<https://www.sol-expert-group.de/Producten-op-zonne-energie/Modellen-van-hout/In-elkaar-te-steken-houten-bouwsets-op-zonne-energie/Zonne-raceauto::1113.html?language=nl>

SOL-EXPERT kits keep you wanting more: detailed instructions, accurately fitting parts, high quality standard!

SOL-EXPERT group, C.Repyk

Mehlisstrasse 19 - D-88255 Baidnt

Tel.: +49 (0)7502 - 94115-0 - Fax: +49 (0)7502 - 94115-99

info@sol-expert-group.de - www.sol-expert-group.de

Find more cool kits at:

www.sol-expert-group.de



Please return electronic parts to a certified provider at the end of their useful life!

Changes and error reserved.

Juli 2020 / Christian Repky ©

