



Please return the parts to a certified provider at the end of their useful life!



4 03 73 73 17 88 98 9

1

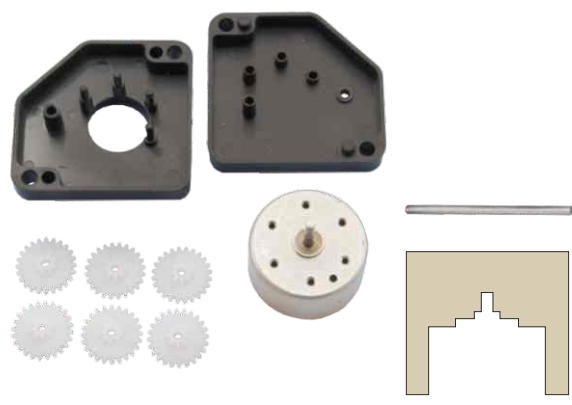

Energy station „Green energy“

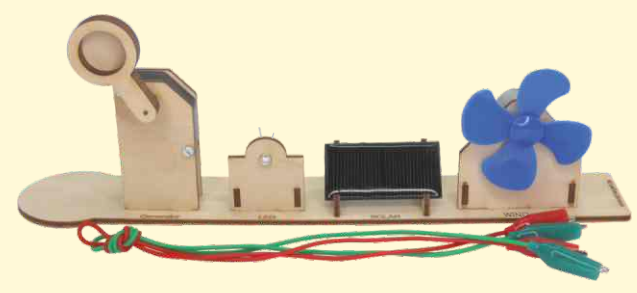

MADE IN EUROPE

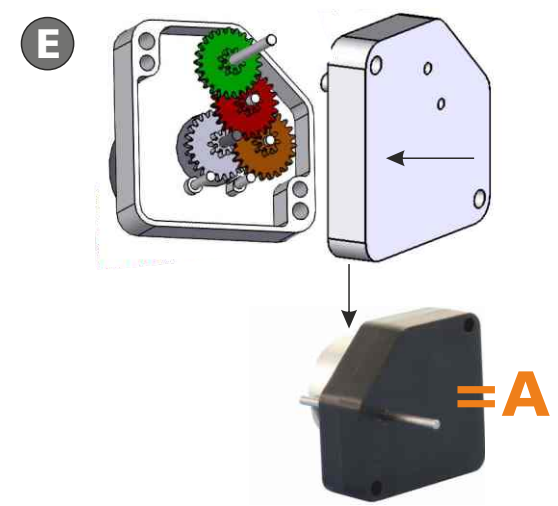
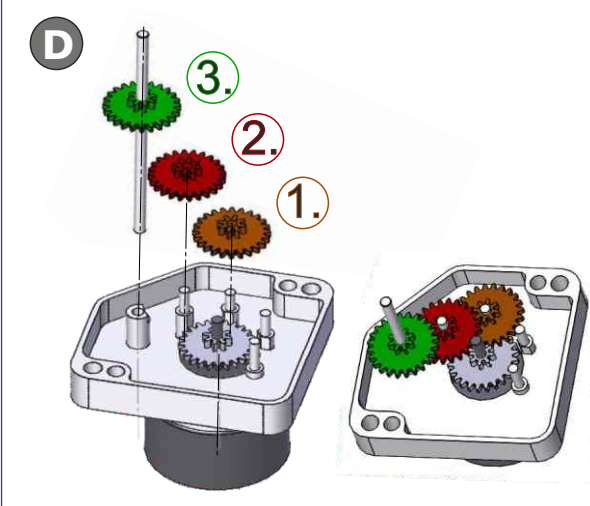
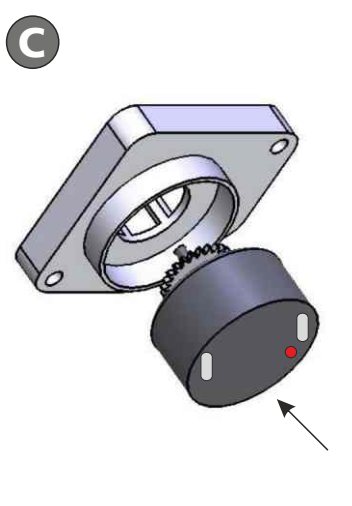
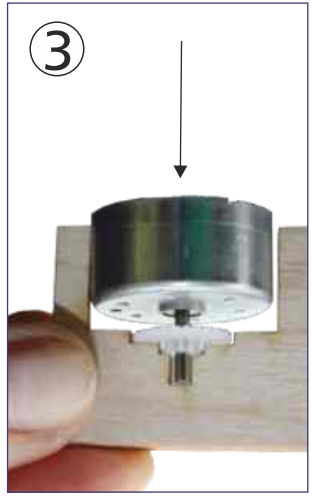
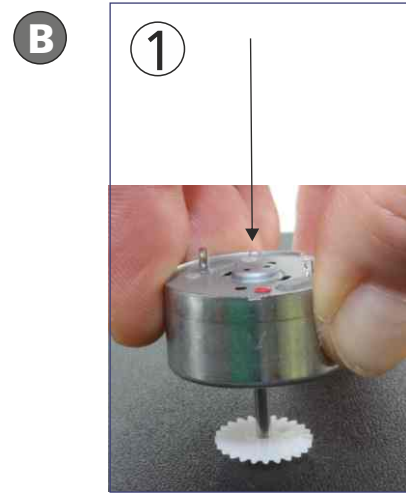
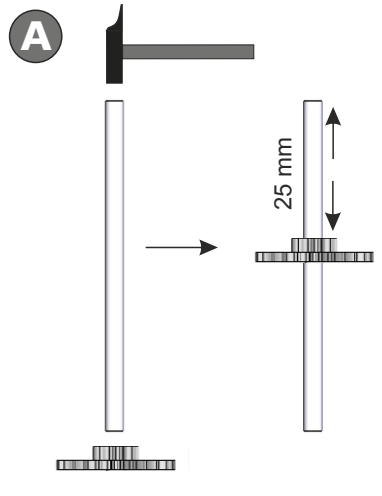

2

2 x $\odot 10$

2 x 7 M3 x 22 mm

1 x

1 x

1 x

1 x 13

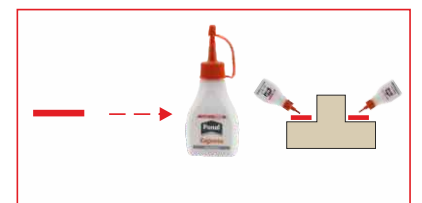
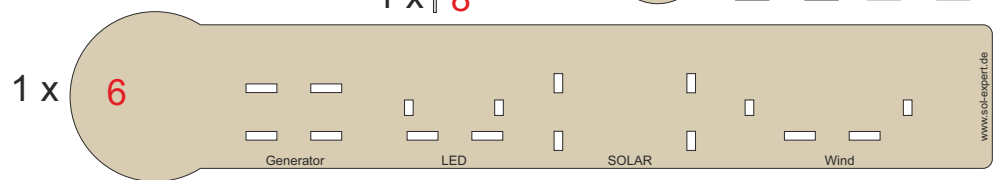
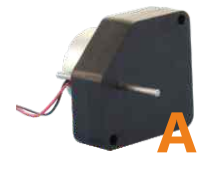
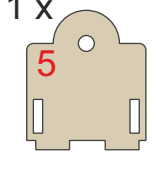
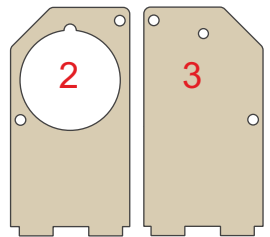
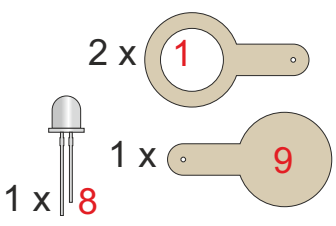
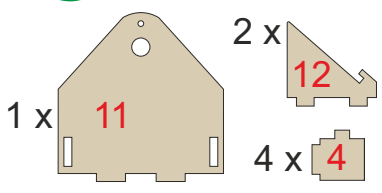

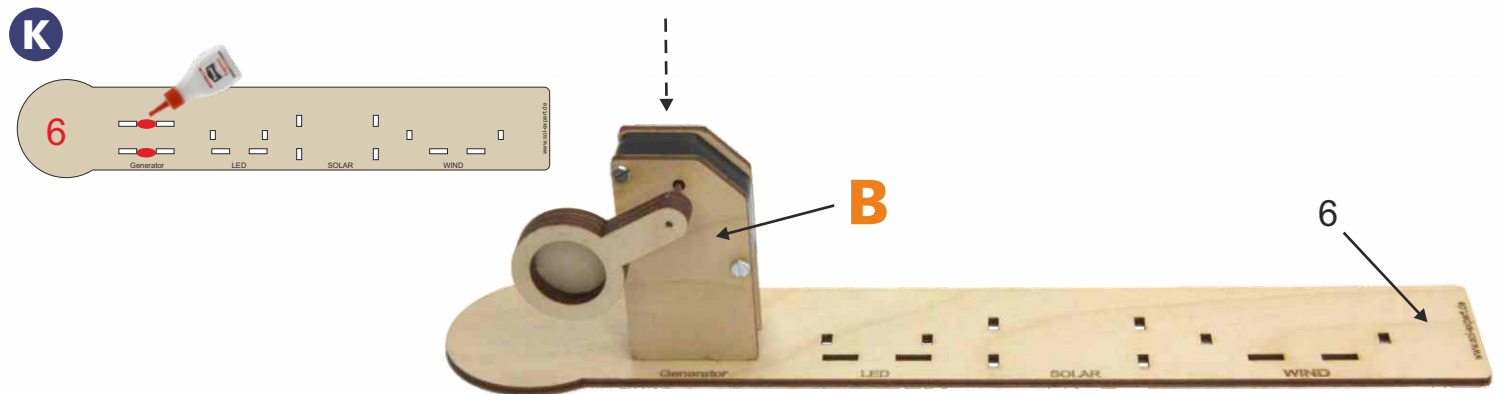
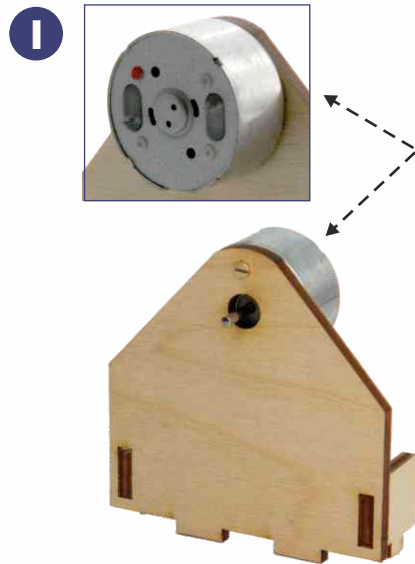
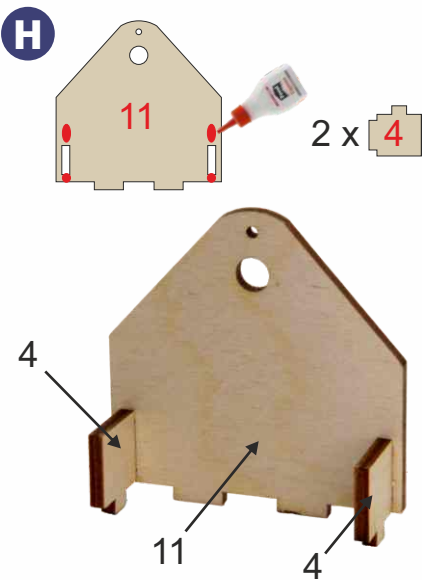
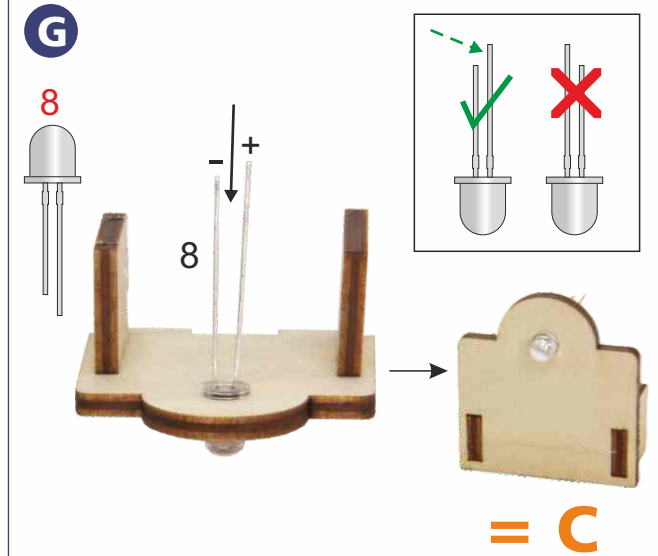
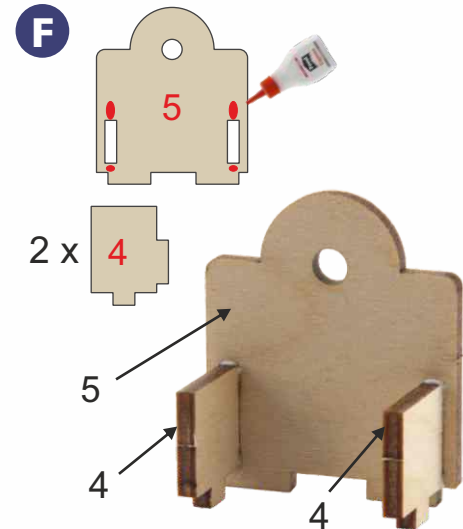
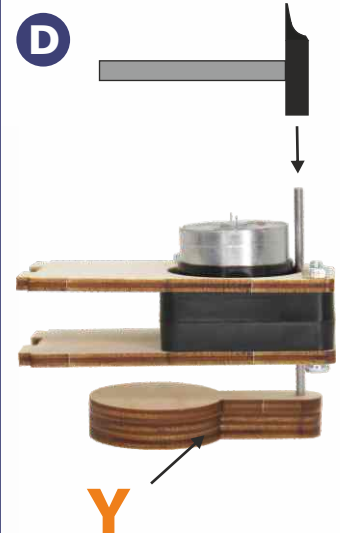
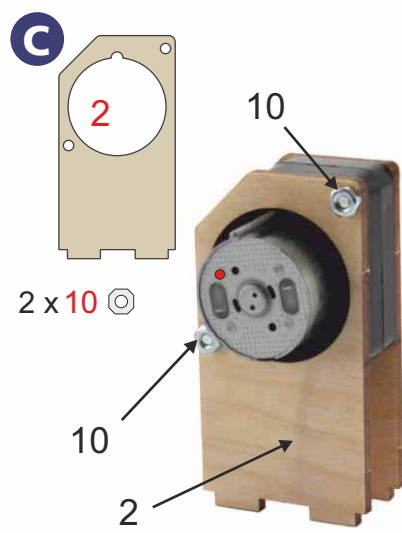
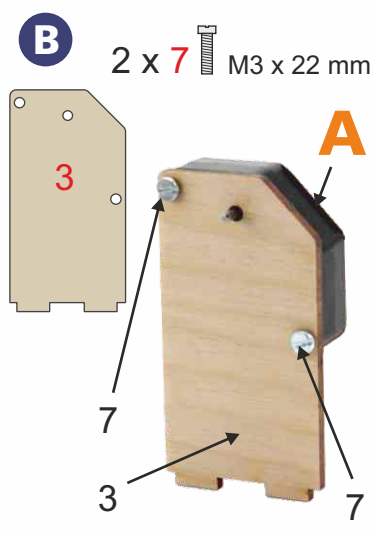
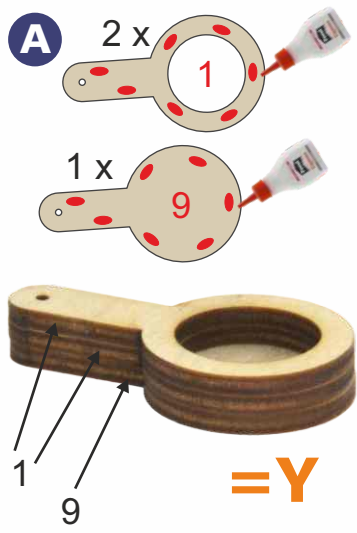

L

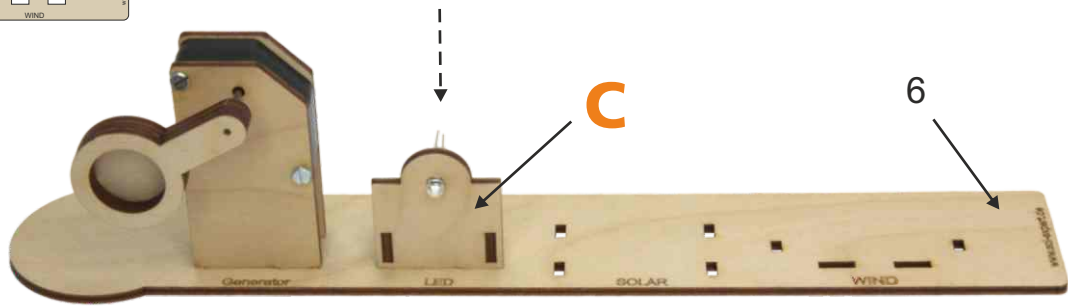
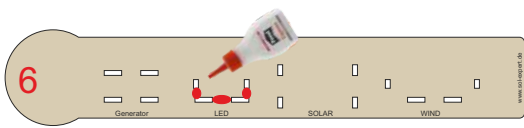

M

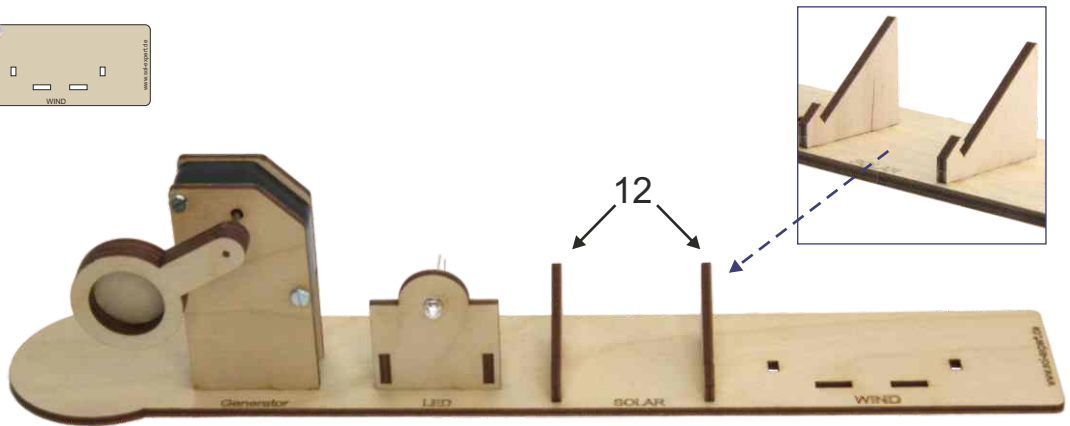
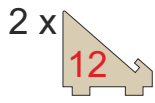
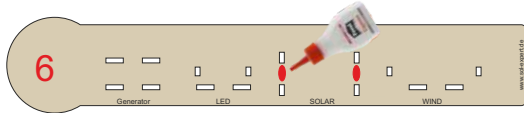

N

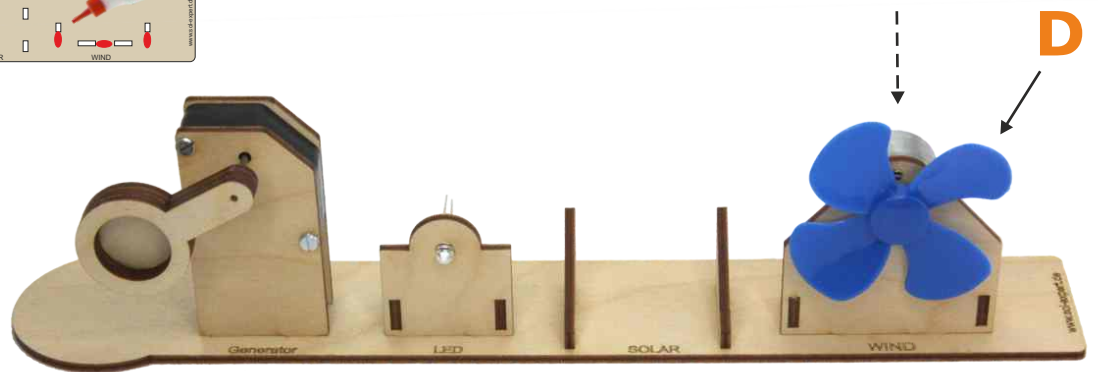
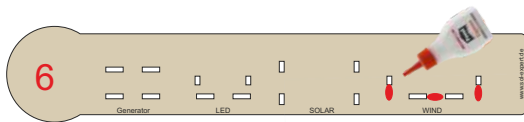

O

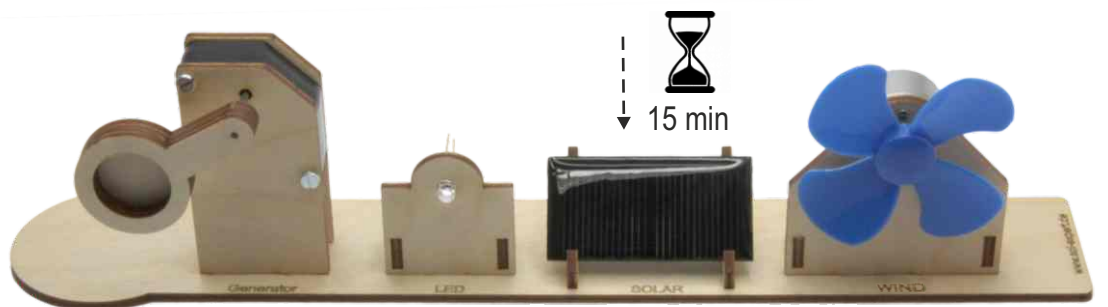
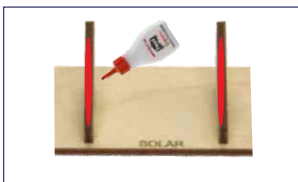

3 EXPERIMENTS



1



Producing power with a hydropower station (rotation)

Build the following experiment as shown below:

	<p>Connect the generator and LED using the alligator clips as shown:</p> <p>①</p>	<p>Now turn the crank in the direction shown!</p> <p>②</p>
--	-----------------------------------------------------------------------------------	------------------------------------------------------------



Hydropower station

In this experiment we turned the crank by hand and the LED lit up. I.e. we were able to generate energy.

This works the same with a **hydropower station**. The direction in which water flows is converted into a rotation. This rotation then drives a generator, which then produces electrical power, hence e.g. supplying electricity for a house. Hydropower stations can be found in rivers (river power plants) or e.g. in the Alps at dammed lakes (reservoir power stations).

2



Generating electricity by solar plant

Build the following experiment as shown below:

	<p>Connect the solar module and LED using the alligator clips, as shown:</p> <p>①</p>	<p>② Now illuminate the solar cell with a torch or sunlight!</p> <p>②</p>
--	---------------------------------------------------------------------------------------	---------------------------------------------------------------------------



Solar plant

We were able to make the LED light up by illuminating the solar cell. This is the same concept as a **solar plant** (also called **photovoltaic system**). Sunlight is converted to electrical power.

Here, remember the more sunlight strikes the solar cell, the more energy is produced. Wherever there is a lot of sunlight, photovoltaics can easily and reliably generate energy, silent and environmentally friendly.

3



Generating electricity by wind power

Build the following experiment as shown below:

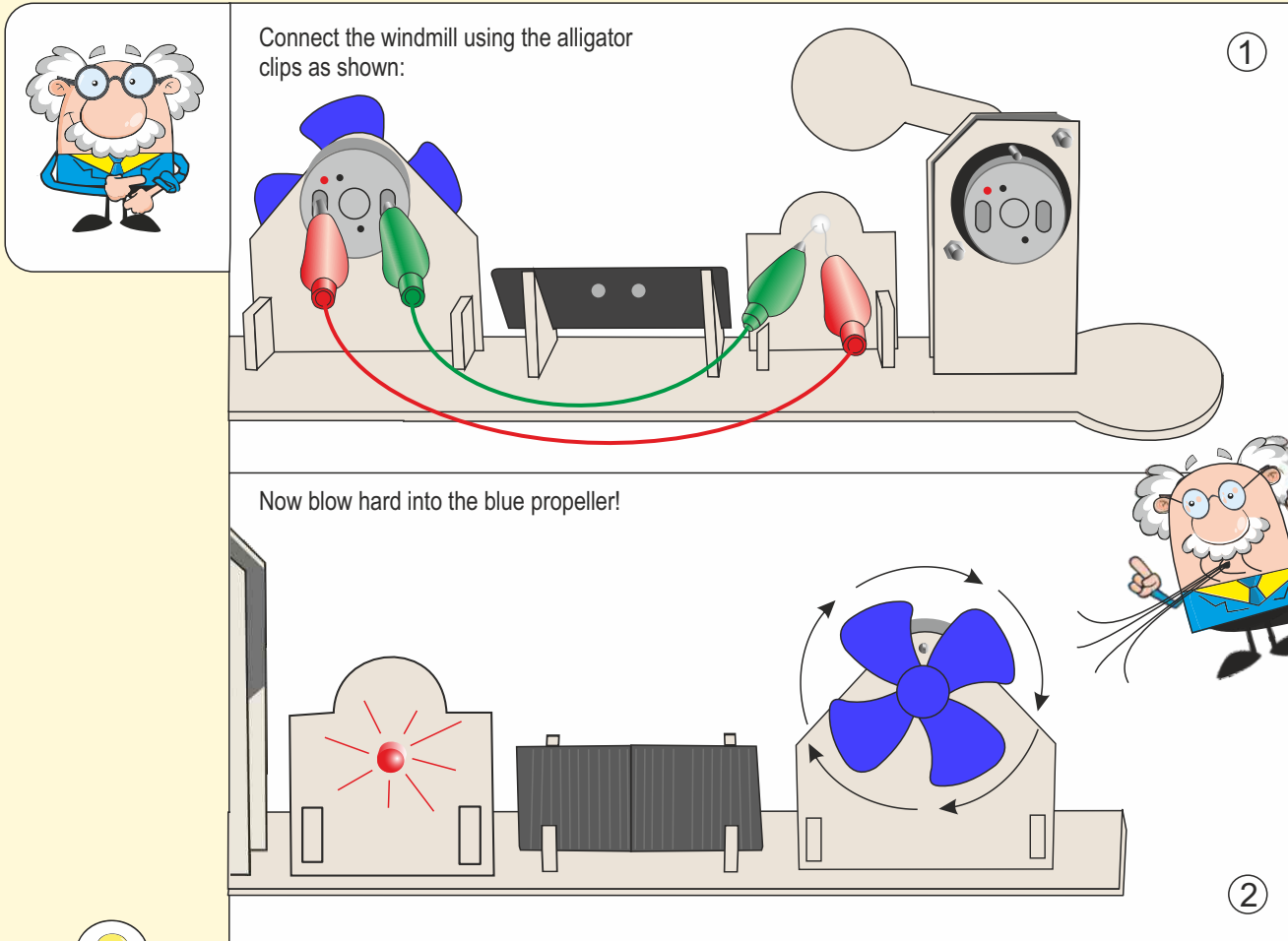

Wind power plants

The LED lit up after we blew hard into the propeller. In large **wind power plants** wind drives the wind turbine blades which in turn generate a rotation of the hub.

This rotation is then converted into electrical power. This technology is particularly excellent in windy areas and produces environmentally-friendly energy.

What did you learn from the experiments?

Environmentally-friendly energy can be generated by:

- Hydropower stations
- Solar plants
- and Wind power plants

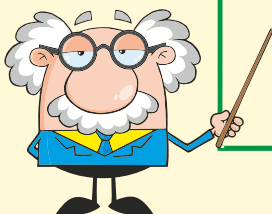

4

How a generator works:

Build the following experiment as shown below:



Connect the generator and the motor using the alligator clips as shown:

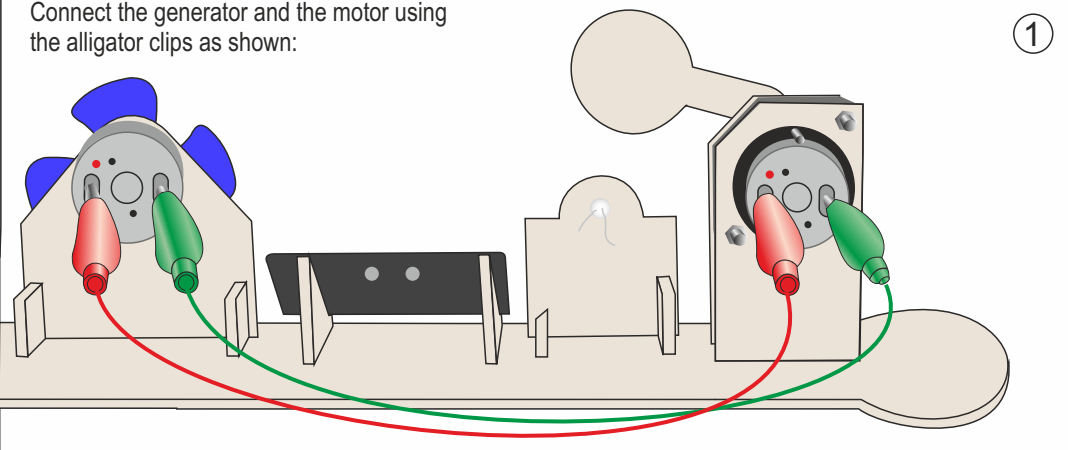

Now turn the crank in the direction shown!

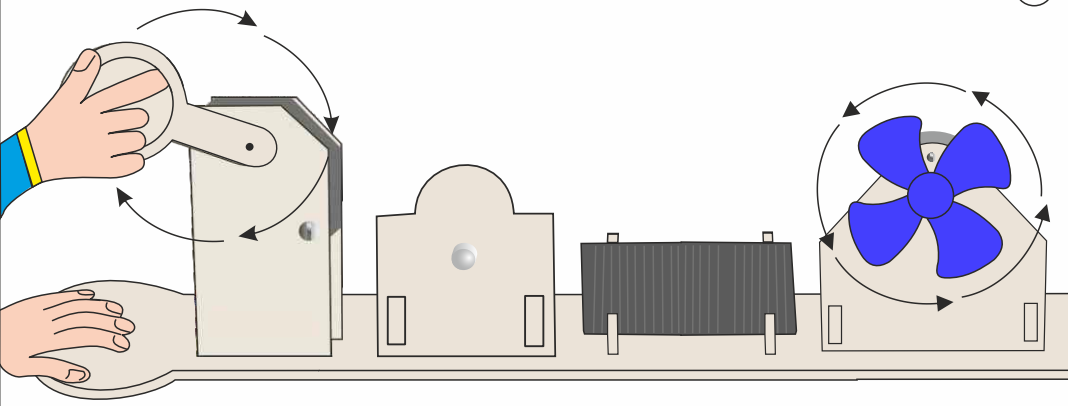

Now turn the crank again in the direction shown and see what happens!

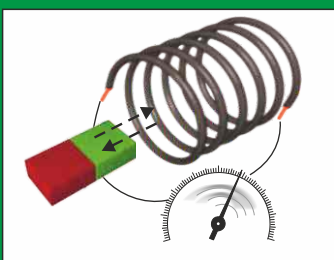
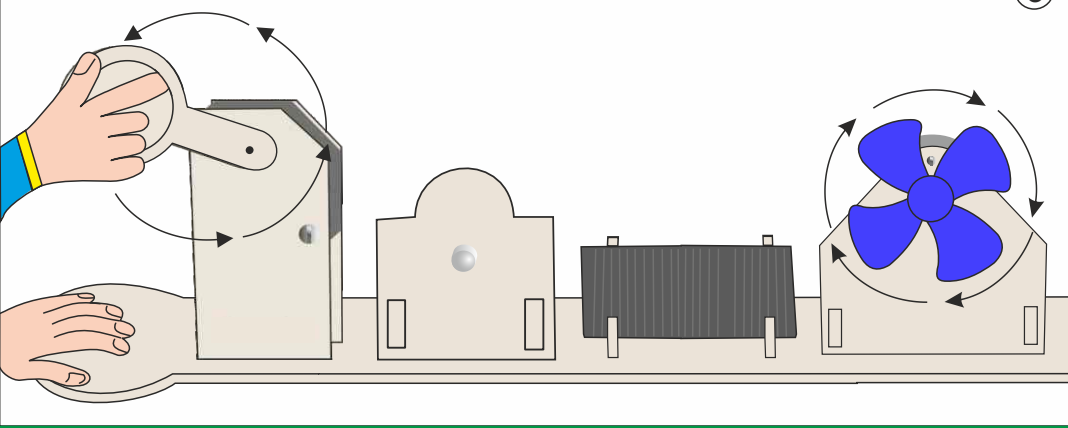

Generator

Once the generator crank is turned, the motor begins to turn. So we were able to produce power using the **generator**. If we change the direction of rotation of the crank, the motor will also turn, but this time in the other direction. The rotational direction of the motor is entirely determined by the rotational direction of the crank.

▶ **Producing power with a generator, how it works:** A generator converts rotation (mechanical energy) into electric power. This for example occurs when a magnet is moved inside a coil (wire wound several times) (see image). The electric power generated by the motion can e.g. make a light-emitting diode light up:

TIP:

You can also try this experiment:

- Wind power makes the generator turn – connect the propeller to the generator and blow hard!
- Solar power allows the generator to turn – connect the solar module to the generator and aim the solar module at the sun!

